



GUARNIZIONI
SEALS



KTG

KIT GUARNIZIONI PER TESTATE DI GUIDA SEALS KIT FOR PILOT BOSSES

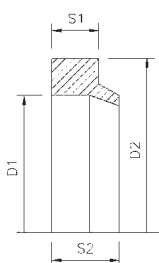

Raschiatore
Wiper

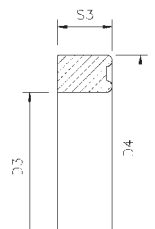

Tenuta stelo
Rod seal

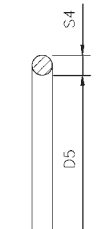

- OR -

Tenuta interna
Inner seal

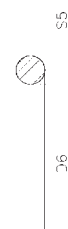

- OR -

Tenuta in angolo
Angle seal

Cod.	D1	D2	S1	S2	D3	D4	S3	D5	S4	ISO	D6	S5	ISO
KTG 322027	20	28	5	7	20	28	5,8	26,64	2,64	121	25,07	2,62	120
KTG 352032	20	28	5	7	20	28	5,8	28,17	3,53	216	28,24	2,62	122
KTG 352232	22	30	5	7	22	30	5,8	28,17	3,53	216	28,24	2,62	122
KTG 402032	20	28	5	7	20	28	5,8	32,92	3,53	219	34,59	2,62	126
KTG 402232	22	30	5	7	22	30	5,8	32,92	3,53	219	34,59	2,62	126
KTG 402532	25	33	5	7	25	33	5,8	32,92	3,53	219	34,59	2,62	126
KTG 452232	22	30	5	7	22	30	5,8	37,69	3,53	222	40,94	2,62	130
KTG 452532	25	33	5	7	25	33	5,8	37,69	3,53	222	40,94	2,62	130
KTG 502535	25	33	5	7	25	33	5,8	42,86	3,53	826	44,12	2,62	132
KTG 503035	30	38	5	7	30	40	6,5	42,86	3,53	826	44,12	2,62	132
KTG 503535	35	43	5	7	35	43	5,8	42,86	3,53	826	44,12	2,62	132
KTG 553035	30	38	5	7	30	40	6,5	49,2	3,53	830	48,9	2,62	135
KTG 553535	35	43	5	7	35	45	7,0	52,4	3,53	830	48,9	2,62	135
KTG 602540	25	33	5	7	25	33	6,5	52,4	3,53	832	53,64	2,62	138
KTG 603040	30	38	5	7	30	40	6,5	52,4	3,53	832	53,64	2,62	138
KTG 603540	35	43	5	7	35	45	7,0	52,4	3,53	832	53,64	2,62	138
KTG 604040	40	48	5	7	40	48	5,8	52,4	3,53	832	53,64	2,62	138
KTG 633040	30	38	5	7	30	40	6,5	57,15	3,53	835	56,82	2,62	140
KTG 633540	35	43	5	7	35	45	7,0	57,15	3,53	835	56,82	2,62	140
KTG 634040	40	48	5	7	40	48	5,8	57,15	3,53	835	56,82	2,62	140
KTG 653040	30	38	5	7	30	40	6,5	58,74	3,53	836	58,42	2,62	141
KTG 653540	35	43	5	7	35	45	7,0	58,74	3,53	836	58,42	2,62	141
KTG 654040	40	48	5	7	40	48	5,8	58,74	3,53	836	58,42	2,62	141
KTG 703040	30	38	5	7	30	40	6,5	63,5	3,53	839	64,77	2,62	145
KTG 703540	35	43	5	7	35	45	7,0	63,5	3,53	839	64,77	2,62	145
KTG 704040	40	48	5	7	40	50	10	63,5	3,53	839	64,77	2,62	145
KTG 704540	45	53	5	7	45	55	7	63,5	3,53	839	64,77	2,62	145
KTG 705040	50	58	5	7	50	60	7	73,02	3,53	845	71,12	2,62	149
KTG 753050	30	38	5	7	30	40	6,5	68,26	3,53	842	66,34	2,62	146
KTG 753550	35	43	5	7	35	45	7	68,26	3,53	842	66,34	2,62	146
KTG 754050	40	48	5	7	40	50	10	68,26	3,53	842	66,34	2,62	146
KTG 754550	45	53	5	7	45	55	7	68,26	3,53	842	66,34	2,62	146
KTG 803050	30	38	5	7	30	40	6,5	73,02	3,53	845	71,12	2,62	149
KTG 803550	35	43	5	7	35	45	7	73,02	3,53	845	71,12	2,62	149
KTG 804050 B	40	48	5	7	40	50	10	73,02	3,53	845	71,12	2,62	149
KTG 804050	40	48	5	7	40	50	10	73,02	3,53	845	71,12	2,62	149

• Su richiesta possiamo fornire qualsiasi tipo di guarnizione
• We are able to supply all kind of seals, on demand

KTG

KIT GUARNIZIONI PER TESTATE DI GUIDA SEALS KIT FOR PILOT BOSSES

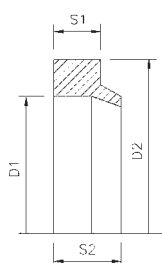

Raschiatore
Wiper

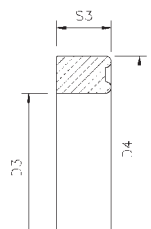

Tenuta stelo
Rod seal

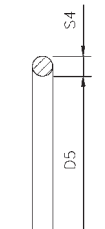

- OR -

Tenuta interna
Inner seal

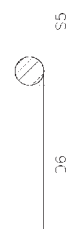

- OR -

Tenuta in angolo
Angle seal

Cod.	D1	D2	S1	S2	D3	D4	S3	D5	S4	ISO	D6	S5	ISO
KTG 804550	45	53	5	7	45	55	7	73,02	3,53	845	71,12	2,62	149
KTG 805050 B	50	58	5	7	50	60	7	73,02	3,53	845	71,12	2,62	149
KTG 805050	50	58	5	7	50	60	7	73,02	3,53	845	71,12	2,62	149
KTG 806050	60	68	5	7	60	72	9	73,02	3,53	845	71,12	2,62	149
KTG 853550	35	43	5	7	35	45	7	74,63	3,53	619	75,87	2,62	151
KTG 854050	40	48	5	7	40	50	10	74,63	3,53	619	75,87	2,62	151
KTG 854550	45	53	5	7	45	55	7	74,63	3,53	619	75,87	2,62	151
KTG 855050	50	58	5	7	50	60	7	74,63	3,53	619	75,87	2,62	151
KTG 904050	40	48	5	7	40	50	10	79,63	5,33	620	82,22	2,62	152
KTG 904550	45	53	5	7	45	55	7	79,63	5,33	620	82,22	2,62	152
KTG 905050	50	58	5	7	50	60	7	79,63	5,33	620	82,22	2,62	152
KTG 906050	60	68	5	7	60	72	9	79,63	5,33	620	82,22	2,62	152
KTG 1004070	40	48	5	7	40	48	5,8	89,69	5,33	621	88,57	2,62	153
KTG 1004570	45	53	5	7	45	55	7	89,69	5,33	621	88,57	2,62	153
KTG 1005070	50	58	5	7	50	60	7	89,69	5,33	621	88,57	2,62	153
KTG 1005570	55	63	5	7	55	65	6,3	89,69	5,33	621	88,57	2,62	153
KTG 1006070	60	68	5	7	60	72	9	89,69	5,33	621	88,57	2,62	153
KTG 1007070	70	78	5	7	70	85	11	89,69	5,33	621	88,57	2,62	153
KTG 1104560	45	53	5	7	45	55	7	100	5,33	622	94,92	2,62	154
KTG 1105060	50	58	5	7	50	60	7	100	5,33	622	94,92	2,62	154
KTG 1106070	60	68	5	7	60	72	9	100	5,33	622	94,92	2,62	154
KTG 1107070	70	78	5	7	70	85	11	100	5,33	622	94,92	2,62	154
KTG 1108070	80	88	5	7	80	95	12,5	100	5,33	622	94,92	2,62	154
KTG 1206070	60	68	5	7	60	72	9	109,5	5,33	623	107,6	2,62	156
KTG 1207070	70	78	5	7	70	85	11	109,5	5,33	623	107,6	2,62	156
KTG 1256080	60	68	5	7	60	72	9	113,6	5,33	349	113,9	2,62	157
KTG 1257080	70	78	5	7	70	85	11	113,6	5,33	349	113,9	2,62	157
KTG 1407080	70	78	5	7	70	85	11	132,7	5,33	208	133	2,62	160
KTG 1408080	80	88	5	7	80	96	9,5	132,7	5,33	208	133	2,62	160
KTG 1507090	70	78	5	7	70	85	11	139	5,33	357	139,3	2,62	161
KTG 1508090	80	88	5	7	80	96	9,5	139	5,33	357	139,3	2,62	161
KTG 1608090	80	88	5	7	80	96	9,5	148,5	5,33	360	152	2,62	163
KTG 1609090	90	102	7	12	90	105	11,5	148,5	5,33	360	152	2,62	163

KTG

KIT GUARNIZIONI PER TESTATE DI GUIDA SEALS KIT FOR PILOT BOSSES

Cod.	Raschiatore Wiper				Tenuta stelo Rod seal			- OR - Tenuta interna Inner seal			- OR - Tenuta in angolo Angle seal			Guida stelo Rod guide seal			Anti-trusione Antiextrusion ring	
	D1	D2	S1	S2	D3	D4	S3	D5	S4	ISO	D6	S5	ISO	D7	D8	S6	D9	S7
KTG 18010092	100	112	7		100	113	13,5	166,7	6,99	628	177,4	3,53	262	100	106	13	166,7	2,5
KTG 18012092	120	132	7		120	135	12,5	166,7	6,99	628	177,4	3,53	262	120	126	13	166,7	2,5
KTG 20010092	100	112	7		100	113	13,5	187,3	6,99	882	196,4	3,53	266	100	106	13	187,3	2,5
KTG 20012092	120	132	7		120	135	12,5	187,3	6,99	882	196,4	3,53	266	120	126	13	187,3	2,5
KTG 250150117	150	162	7		150	170	14,5	234,3	6,99	678	240,9	3,53	272	150	156	13	234,3	2,5



KTGT

KIT GUARNIZIONI PER TESTATE DI GUIDA TUFFANTI SEALS KIT FOR PLUNGER PILOT BOSSES

Cod.	Raschiatore Wiper				Tenuta stelo Rod seal			- OR - Tenuta interna Inner seal			- OR - Tenuta in angolo Angle seal		
	D1	D2	S1	S2	D3	D4	S3	D5	S4	ISO	D6	S5	ISO
KTGT 254532	25	33	5	7	25	33	5,8	29,82	2,6	123	29,82	2,6	123
KTGT 305032	30	38	5	7	30	38	5,8	34,59	2,62	126	34,59	2,62	126
KTGT 355532	35	43	5	7	35	43	5,8	39,34	2,62	129	39,34	2,62	129
KTGT 406035	40	48	5	7	40	48	5,8	44,12	2,62	132	44,12	2,62	132
KTGT 456535	45	53	5	7	45	55	7	50,47	2,62	136	50,47	2,62	136
KTGT 507040	50	58	5	7	50	60	7	53,64	2,62	138	53,64	2,62	138
KTGT 608040	60	68	5	7	60	70	7	64,77	2,62	145	64,77	2,62	145
KTGT 7009450	70	78	5	7	70	85	11,5	85,32	3,53	237	95,32	3,53	237
KTGT 8010550	80	88	5	7	80	96	9,5	91,67	3,53	239	91,67	3,35	239
KTGT 10014042	100	112	7	12	100	113	12,5	-	-	-	120,24	3,35	248

KPIS

KIT GUARNIZIONI PER PISTONI SEAL KIT FOR PISTON

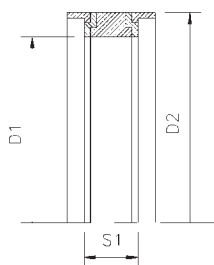

Tenuta pistone
Piston seal

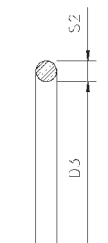

- OR -

Tenuta interna
Inner seal

Cod.	D1	D2	S1	D3	S2	ISO
KPIS 321530	24	32	15,5	15,08	2,62	616
KPIS 351540	25	35	16,4	15,08	2,62	616
KPIS 401540	30	40	16,4	15,08	2,62	616
KPIS 451540	35	45	16,4	15,08	2,62	616
KPIS 501540	34	50	18,4	15,08	2,62	616
KPIS 502040	34	50	18,4	20,3	2,62	117
KPIS 552040	39	55	18,4	20,3	2,62	117
KPIS 602050	44	60	18,4	20,3	2,62	117
KPIS 602445	44	60	18,4	23,47	2,62	119
KPIS 602750	44	60	18,4	26,57	3,53	215
KPIS 632050	47	63	18,4	20,3	2,62	117
KPIS 632750	47	63	18,4	26,57	3,53	215
KPIS 652050	50	65	18,4	20,3	2,62	117
KPIS 652445	50	65	18,4	23,47	2,62	119
KPIS 652550	44	60	18,4	25,07	2,62	119
KPIS 702050	50	70	22,4	20,3	2,62	117
KPIS 702445	50	70	22,4	23,47	2,62	119
KPIS 702750	50	70	22,4	26,57	3,53	215
KPIS 752445	55	75	22,4	23,47	2,62	119
KPIS 752750	55	75	22,4	26,57	3,53	215
KPIS 802445	60	80	22,4	23,47	2,62	119
KPIS 802750	60	80	22,4	26,57	3,53	215
KPIS 803050	60	80	22,4	29,74	3,53	217
KPIS 852445	65	85	22,4	23,47	2,62	119
KPIS 852750	65	85	22,4	26,57	3,53	215
KPIS 902750	70	90	22,4	26,57	3,53	215
KPIS 903350	70	90	22,4	32,92	3,53	219
KPIS 1002750	75	100	22,4	26,57	3,53	215
KPIS 1003350	75	100	22,4	32,92	3,53	219
KPIS 1103350	85	110	22,4	32,92	3,53	219
KPIS 1104050	85	110	22,4	39,7	3,53	824
KPIS 1204050	95	120	22,4	39,7	3,53	824
KPIS 1254050	100	125	25,4	39,7	3,53	824
KPIS 1404058	115	140	25,4	39,7	3,53	824
KPIS 1504058	125	150	25,4	39,7	3,53	824
KPIS 1605158	135	160	25,4	50,8	3,53	831

• Su richiesta possiamo fornire qualsiasi tipo di guarnizione
• We are able to supply all kind of seals, on demand

KEPF

KIT GUARNIZIONI PER PISTONI FILETTATI SEAL KIT FOR THREADED PISTONS

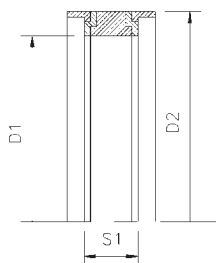

Tenuta pistone
Piston seal

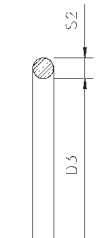

- OR -

Tenuta interna
Inner seal

Cod.	D1	D2	S1	D3	S2	ISO
KEPF 602445	44	60	18,4	20,63	2,62	812
KEPF 632445	47	63	18,4	20,63	2,62	812
KEPF 702750	50	70	22,4	23,81	2,62	814
KEPF 702450	50	70	22,4	20,63	2,62	812
KEPF 803350	60	80	22,4	29,82	2,62	123
KEPF 903350	70	90	22,4	29,82	2,62	123
KEPF 1003350	75	100	22,4	29,82	2,62	123

KEPF...C

KIT GUARNIZIONI PER PISTONI FILETTATI CON CENTRAGGIO SEAL KIT FOR THREADED PISTONS WITH CENTERING

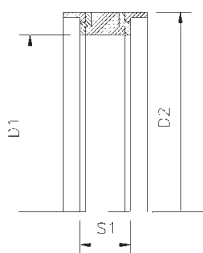

Tenuta pistone - Piston seal



- OR -

Tenuta interna - Inner seal

Cod.	D1	D2	S1	D3	S2	ISO
KEPF401836C	30	40	16,4	20,29	2,62	117
KEPF501840C	34	50	18,4	25,07	2,62	120
KEPF602445C	44	60	18,4	29,82	2,62	123
KEPF6024452C	44	60	18,4	25,07	2,62	120
KEPF702445C	50	70	22,4	25,07	2,62	120
KEPF702750C	50	70	22,4	29,82	2,62	123
KEPF802745C	60	80	22,4	28,17	3,53	216
KEPF802750C	60	80	22,4	28,17	3,53	216
KEPF902750C	70	90	22,4	28,17	3,53	216
KEPF903350C	70	90	22,4	35	35	220
KEPF1003350C	75	100	22,4	34,52	3,53	220

GHK

RASCHIATORI WIPERS

- MATERIALE *Poliuretano Tecolan*
- MATERIAL *Polyurethane Tecolan*

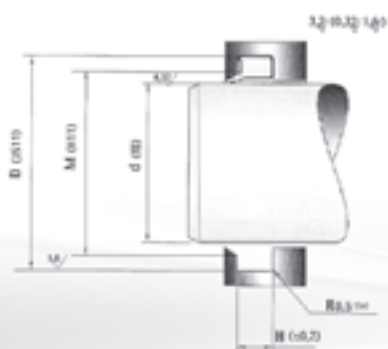

Cod.	d	D	H	M
GHK 306	20	28,6	5,3	23
GHK 307	22	30,6	5,3	25
GHK 308	25	33,6	5,3	28
GHK 311	30	38,6	5,3	33
GHK 313	35	43,6	5,3	38
GHK316	40	48,6	5,3	43
GHK318	45	53,6	5,3	48
GHK322	50	58,6	5,3	53
GHK328	60	68,6	5,3	63
GHK334	70	78,6	5,3	73
GHK339	80	88,6	5,3	83
GHK342	90	102,2	7,1	96
GHK344	100	112,2	7,1	106
GHK348	120	132,2	7,1	126
GHK356	150	162,2	7,1	156

TTI

GUARNIZIONI PER STELO ROD SEALS

- MATERIALE *Poliuretano Tecolan*
- MATERIAL *Polyurethane Tecolan*

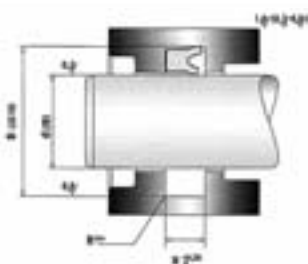

Cod.	d	D	H
TTI1536	20	28	6,3
TTI1543	22	30	6,3
TTI1550	25	33	6,3
TTI1557/1	25	35	9
TTI1569	30	38	6,3
TTI1572	30	40	7,5
TTI1590	35	43	6,3
TTI1593	35	45	8
TTI1610	40	48	6,3
TTI1615	40	50	11
TTI1634	45	55	8
TTI1650	50	60	8
TTI1696	60	70	8
TTI1702	60	72	10
TTI1751,1	70	85	12
TTI1752	70	85	12,5
TSE2130	80	96	10,5
TTI1808	90	105	12,5
TTI1830	100	113	13,5
TTI1868	120	135	12,5
TTI1912	150	170	14,5

TPM

GUARNIZIONI PER PISTONE PISTON SEALS

- MATERIALE NBR + POM + Polyester
- MATERIAL NBR + POM + Polyester

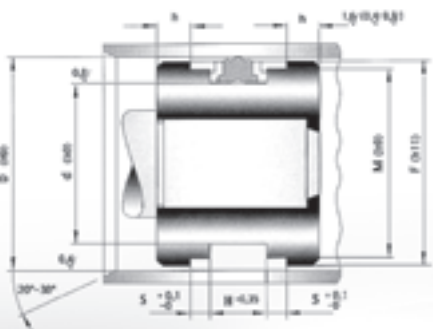

Cod.	D	d	H	S	h	M	F
TPS9503	32	24	15,5	3,2	6	28	31,4
TPM9007	35	25	16,4	6,35	5	31,4	33,5
TPM9008	40	30	16,4	6,35	5	35,4	38,5
TPM9014	45	35	16,4	6,35	5	40,4	43,5
TPM9015	50	34	18,4	6,35	5	45,41	48,7
TPM9018	55	39	18,4	6,35	5	50,37	53,65
TPM9020	60	44	18,4	6,35	5	55,39	58,65
TPM9021	63	47	18,4	6,35	5	58,39	61,63
TPM9024	65	50	18,4	6,35	5	60,41	63,64
TPM9025	70	50	22,4	6,35	6	64,18	68,34
TPM9027	75	55	22,4	6,35	6	69,18	73,32
TPM9028	80	60	22,4	6,35	6	74,16	78,34
TPM9031	85	65	22,4	6,35	6	79,16	83,34
TPM9033	90	70	22,4	6,35	6	84,15	88,31
TPM9036	100	75	22,4	6,35	6	93,14	98,05
TPM9041	110	85	22,4	6,35	6	103,1	108
TPM9046	120	95	22,4	6,35	6	113,1	118,02
TPM9047	125	100	25,4	6,35	6	118,08	122,96
TPM9054	140	115	25,4	9,52	6	132,6	137,5
TPM9058	150	125	25,4	9,52	7	142,6	147,5
TPM9061	160	135	25,4	9,52	7	152,6	157,5

OR

GUARNIZIONI O-RINGS

- MATERIALE NBR
- MATERIAL NBR

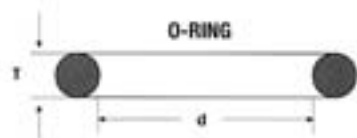

OR	Ø d	sez. T	OR	Ø d	sez. T	OR	Ø d	sez. T	OR	Ø d	sez. T
616	15,08	2,62	145	64,77	2,62	824	39,7	3,53	357	139,07	5,34
117	20,3	2,62	146	66,34	2,62	826	42,86	3,53	360	148,59	5,34
812	20,64	2,62	149	71,12	2,62	830	49,21	3,53	619	74,63	5,34
119	23,47	2,62	151	75,87	2,62	831	50,8	3,53	620	79,77	5,34
814	23,81	2,62	152	82,22	2,62	832	52,4	3,53	621	89,69	5,34
120	25,07	2,62	153	88,57	2,62	835	57,15	3,53	622	100	5,34
121	26,64	2,62	154	94,92	2,62	836	58,74	3,53	623	109,54	5,34
122	28,24	2,62	156	107,62	2,62	839	63,5	3,53	628	166,7	6,99
123	29,82	2,62	157	113,97	2,62	842	68,26	3,53	882	187,3	6,99
126	34,59	2,62	160	133,02	2,62	845	73,02	3,53	678	234,32	6,99
129	39,34	2,62	161	139,37	2,62	237	85,32	3,53			
130	40,94	2,62	163	152,07	2,62	239	91,67	3,53			
132	44,12	2,62	215	26,57	3,53	248	120,24	3,53			
135	48,9	2,62	216	28,17	3,53	262	177,39	3,53			
136	50,47	2,62	217	29,75	3,53	265	194,44	3,53			
138	53,64	2,62	219	32,92	3,53	272	240,89	3,53			
140	56,82	2,62	220	34,52	3,53	349	113,67	5,34			
141	58,42	2,62	222	37,69	3,53	355	132,72	5,34			

• Su richiesta possiamo fornire qualsiasi tipo di guarnizione
• We are able to supply all kind of seals, on demand

GDS

GUARNIZIONI SEALS

- MATERIALE
POLIURETANO TECNOLAN
- MATERIAL
POLYURETHANE TECNOLAN

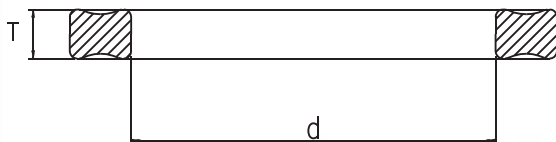

GDS	Ø d	sez.T
121	26.64	2.62
123	29.82	2.62
126	34.59	2.62
129	39.34	2.62
132	44.12	2.62
136	50.47	2.62
138	53.64	2.62
145	64.77	2.62
216	28.17	3.53
219	32.92	3.53
222	37.69	3.53
826	42.86	3.53
830	49.21	3.53

GDS	Ø d	sez.T
832	52.4	3.53
835	57.15	3.53
836	58.74	3.53
839	63.5	3.53
842	68.26	3.53
845	73.02	3.53
237	85.32	3.53
239	91.67	3.53
349	113.67	5.34
864	130.18	5.34
357	139.07	5.34
360	148.59	5.34
619	74.63	5.34

GDS	Ø d	sez.T
620	79.77	5.34
621	89.69	5.34
622	100	5.34
623	109.54	5.34
628	166.7	6.99
882	187.3	6.99
678	234.32	6.99